

Pos. Nr. Pos.no.	Beschreibung Description	Art.-Nr. Art.no.	Preisgruppe Price bracket
7310095	SNCF Y8000		
7320095			
1	Motorvorbau Y.8208 Motor housing Y.8208	154338	30
2	TS - Fenster+Lichtnägel Part set - Windows+light pins	144764	11
3	Lichtnagel Light pin	144765	4
4	Rangiergriff Shunter hand-rail	154330	3
5	Umlaufrahmen Running way frame	154331	18
6	TS - Treppe+Bremseleitung Part set - steps+brake lines	144768	7
7	Tank Tank	154332	10
8	TS - Kasten, Behälter Part set - Boxes, container	154333	10
9	TS - Umlauf Part set - Running way	154334	7
10	TS - Scheibenwischer + Bremsschlauch Part set - Wipers+Brake tubes	144773	9
11	TS - Geländer Part set - Railing	144775	9
12	Platine Onboarddecoder PCB	144776	42
13	Motor KM Motor	145018	25
14	Flexplatine Flexible PCB	144762	11
15	Lautsprecher Loudspeaker	129524	14
16	TS - Gehäuse Part set - Body	154340	6
17	Führerhaus Drivers cab	154339	30
18	Spule Spool	144778	13
19	GF-Schraube M1 6x5 mm GF-Screw	115269	3
20	Pufferanschlagplatte Buffer stop plate	96230	3

Änderungen in Konstruktion und Ausführung vorbehalten  
We reserve the right to change the construction and specification

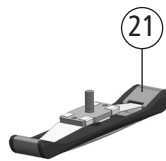
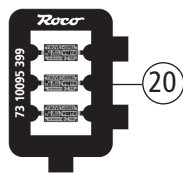
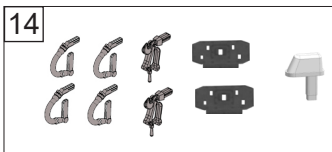
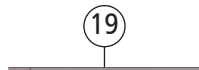
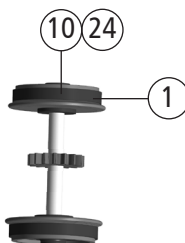
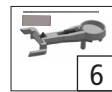
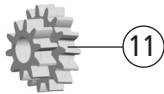
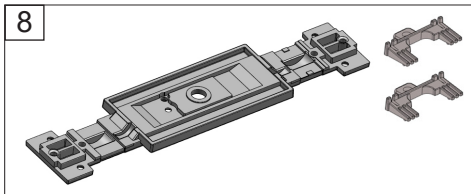
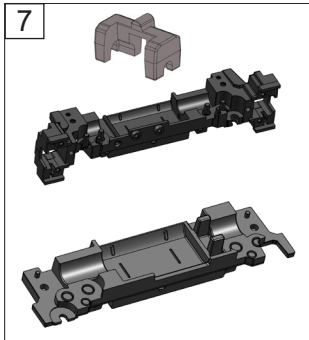
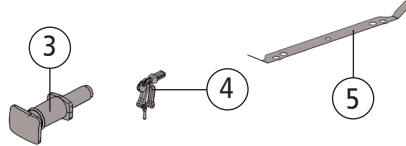
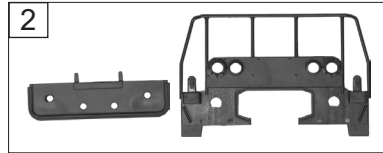

Pos. Nr. Pos.no.	Beschreibung Description	Art.-Nr. Art.no.	Preisgruppe Price bracket
1	Hafrings 10 stk. 10,3-12,8 Traction tyre	40069	---
2	TS - Pufferplatte Part set Buffer plate	154329	14
3	Puffer eckig Buffer rectangular	154336	3
4	Zughaken kurz Coupling hook short	154335	3
5	Radkontakt Wheel contact	144777	9
6	TS - Digital Kupplung Part set - Digital coupling	143765	10
7	Getriebesatz 3tlg. Gear set	144779	9
8	Boden + Flexhalter Bottom + flexible holder	154337	7
9	Radsatz m.Zahnrad o.Haftr. Wheelset w. gearwh. w/o traction tyre	145019	11
10	Radsatz m.Zahnrad m. 2 Haftr. Wheelset w. gearwh. w. 2 traction tyre	146355	12
11	Schnecken Zahnrad Z=10/15 M=0,4 Worm gear	86410	4
12	Zwischenzahnrad Z=12 M=0,4 Intermediate gear wheel	114163	3
13	Zahnrad Gear wheel	86510	4
14	Zurüstbeutel Bag of accessories	154341	9
15	GF - Schraube M1,6x12 mm GF - Screw	115138	3
16	GF - Schraube M1 6x4 mm GF - Screw	114850	3
17	SK - Schraube M2x5 mm SK - Screw	115205	3
18	SK - Schraube M1,6x3 mm SK - Screw	125023	3
19	Federdraht Flat spring	145095	4
20	Tafelsätze Set of panels	149850	12
<b>AC - Wechselstrom</b>			
21	Schleifer Slider	86030	14
22	GF - Schraube M1 6x3 mm GF - Screw	143760	4
23	Radsatz m.Zahnrad o.Haftr. AC Wheelset w. gearwh. w/o traction tyre	145025	11
24	Radsatz m.Zahnrad m. 2 Haftr. AC Wheelset w. gearwh. w. 2 traction tyre	146361	12